

Exterior Building Materials and Colors

1. Stone Veneer: Travertine at front entry
2. Stone Veneer: Stone at front façade and east elevation
3. Vertical Metal Siding: Pac-Clad board and batten siding 12" wide Night Grey
4. Vertical Wood Siding: Wood Tech Exterior Wall Panel, color Maple
5. Roof Overhand Fascia and Soffit Quality Edge Metal Soffit, Warm Black
6. Windows: Pella Lifestyle Series wood / clad windows exterior color: black
7. Aluminum canopy with tension support rods, color: Standard Haze Gray
8. Front Doors: Solid Wood stained 3 and 4-lite frosted glass
9. Garage and Balcony Access Door: Insulated metal two panel door, upper lite frosted glass, color: Brown
10. Garage Overhead Door: Avante aluminum and glass sectional door, black
11. Lighting at doors: Vertical wall mounted light, brushed aluminum trim
12. Lighting in soffit: CycevSun black recessed lights 4 inch diameter

Exterior Site Materials

- A. Dumpster Enclosure and Portion of Rear Fencing: Cesicia 6' x6' black composite horizontal fence panels and metal posts, top and bottom rails
- B. New rear yard wrought iron fence and gate to match existing fence.
- C. Balcony decking, color: Rainier
- D. Balcony perimeter rail system, color: black with bare metal cable

Front Entry Surround Travertine Stone Panels



WHITE
TRAVERTINE

Stone Verneer front façade and east elevation

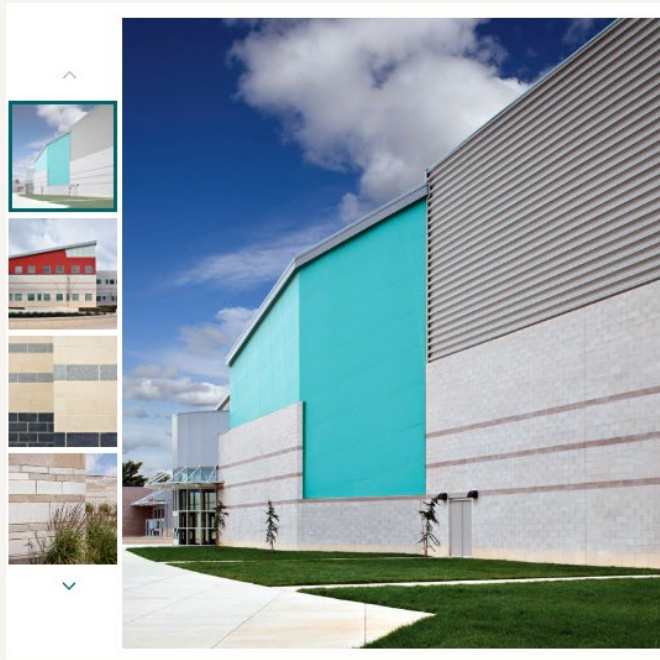

TRENWYTH ARCHITECTURAL MASONRY

TRENDSTONE PLUS

REQUEST SAMPLE

DOWNLOAD BIM CONTENT

COLOR OPTIONS

Show only colors available in your Project Location

AVAILABLE COLORS AT YOUR PROJECT LOCATION



SPECIAL ORDER

[Speak to a sales representative](#) for product availability outside of your project location.

ABOUT TRENDSTONE PLUS

Echelon's Trenwyth Trendstone Plus® ground face masonry units take our Trendstone line to the next level by filling and polishing the exposed faces to a smooth terrazzo finish concrete block.

Pre-finished and integrally colored, Trendstone Plus concrete masonry blocks offer stunning aesthetics, one-step installation, and a maintenance-free finish that is easy to clean.

Available in dozens of colors that can be matched or contrasted with other Trenwyth products, Trendstone Plus CMUs deliver the solution for setting your project apart from the competition.

Contact us to learn how Trendstone Plus masonry can fit into your next project.

PRODUCT DETAILS

- Ground face CMU filled and polished to deliver a smooth terrazzo-like finish
- Ideal for complementing and contrasting with Trendstone® ground face units
- One-step installation
- Maintenance-free and easy to clean
- Mold & moisture resistant
- Highly durable and resilient to fire, impact and moisture damage
- Wide array of colors for ultimate design flexibility
- Sound absorbing units available
- Over-sized units available
- Graffiti-resistant

COLOR MIX



MODESTO 70%

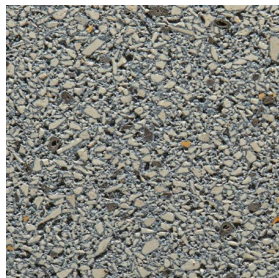

SKY 10%

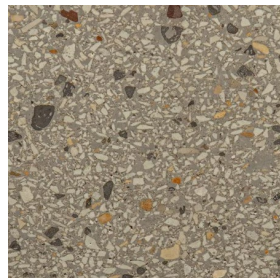

HAYDITE 10%



BUFF 10%

BOARD AND BATTEN



WHERE TIMELESS DESIGN MEETS MODERN ELEGANCE

The Board and Batten panel system provides a timeless design aesthetic for commercial and residential wall applications. It uses a concealed fastener system to maintain clean lines and a rhythmic pattern of alternating wide vertical boards and narrower elevated battens. The $\frac{3}{4}$ " batten depth and 2" width create dimensional interest while keeping trim offsets to a minimum. Board and Batten panels blend smoothly into various architectural styles. Whether creating a cozy and inviting facade or a bold and striking statement, Board and Batten exterior wall panels remain a versatile tool for architectural creativity.

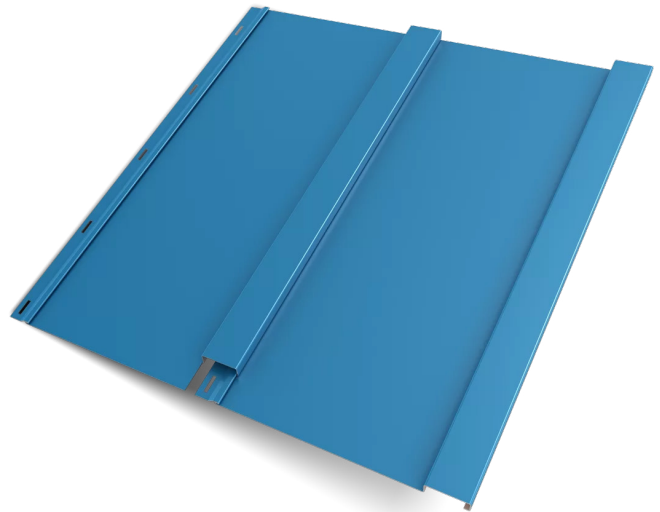

FEATURES

- ▶ Installs with concealed mechanical fasteners through pre-punched holes
- ▶ Vertical wall applications only
- ▶ Widths - 12", 16"
- ▶ Batten is 2" wide and $\frac{3}{4}$ " deep on all panel widths
- ▶ Maximum length for steel is 30 feet
- ▶ Maximum length for aluminum is 22 feet



HQ: 1005 Tonne Road
Elk Grove Village, IL 60007
P: 800-PAC-CLAD
F: 800-722-7150

9060 Junction Drive
Annapolis Junction, MD 20701
P: 800-344-1400
F: 301-953-7627

10551 PAC Road
Tyler, TX 75707
P: 800-441-8661
F: 903-581-8592

102 Northpoint Parkway
Acworth, GA 30102
P: 800-272-4482
F: 770-420-2533

1800 S. 7th Ave., Suite 130
Phoenix, AZ 85007
P: 833-750-1935
F: 602-254-6504

9817 233rd Ave. E Suite A
Bonney Lake, WA 98391
P: 253-501-2450



BOARD AND BATTEN

MATERIALS

.032 aluminum

24 gauge steel

SPECS

12", 16" Wide

3/4"

High

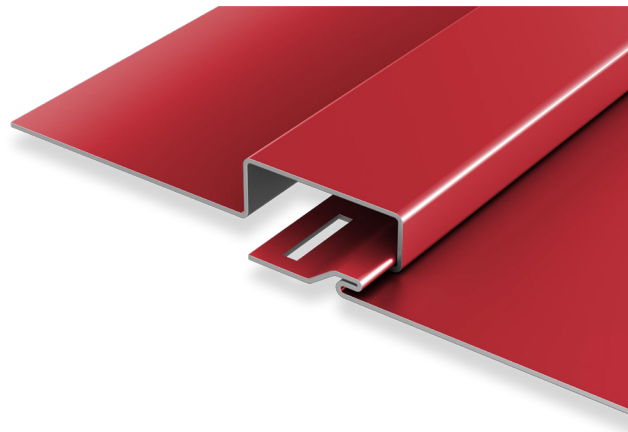

FEATURES

- ▶ Installs with concealed mechanical fasteners through pre-punched holes
- ▶ Vertical wall applications only
- ▶ Widths - 12", 16"
- ▶ Batten is 2" wide and 3/4" deep on all panel widths
- ▶ Maximum length for steel is 30 feet
- ▶ Maximum length for aluminum is 22 feet

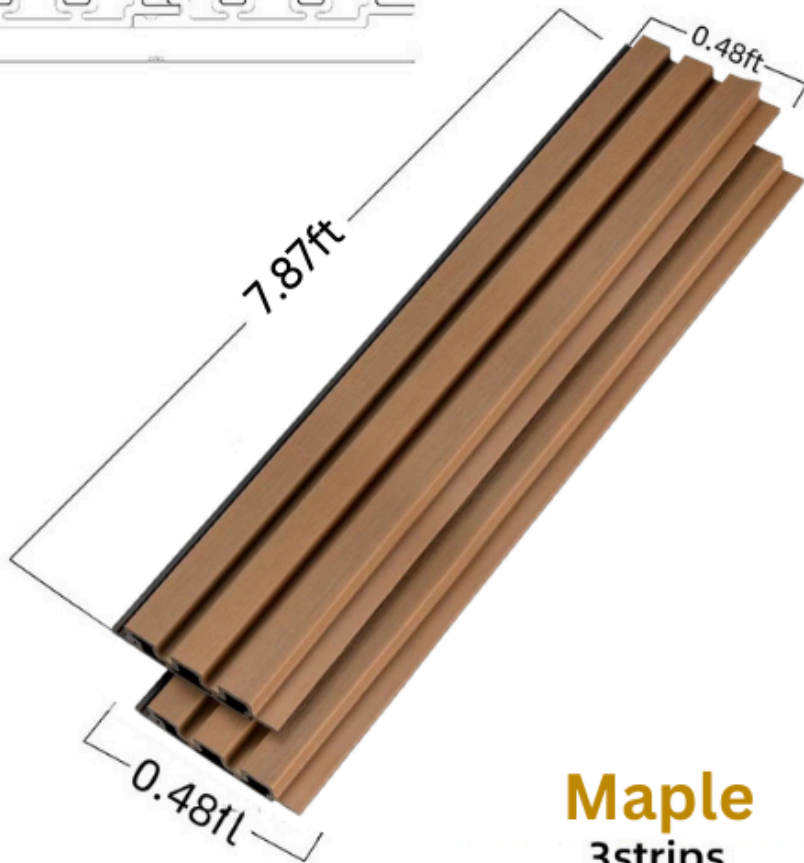
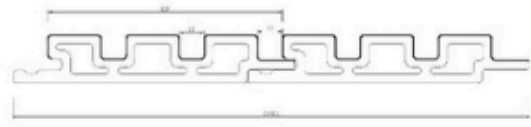

Maple
3strips

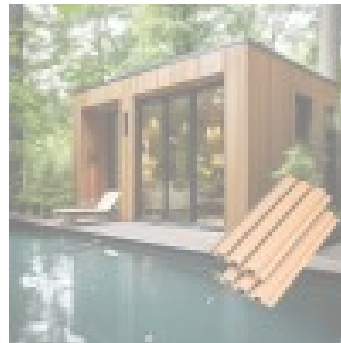
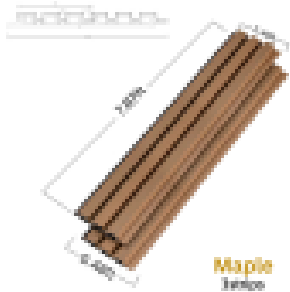
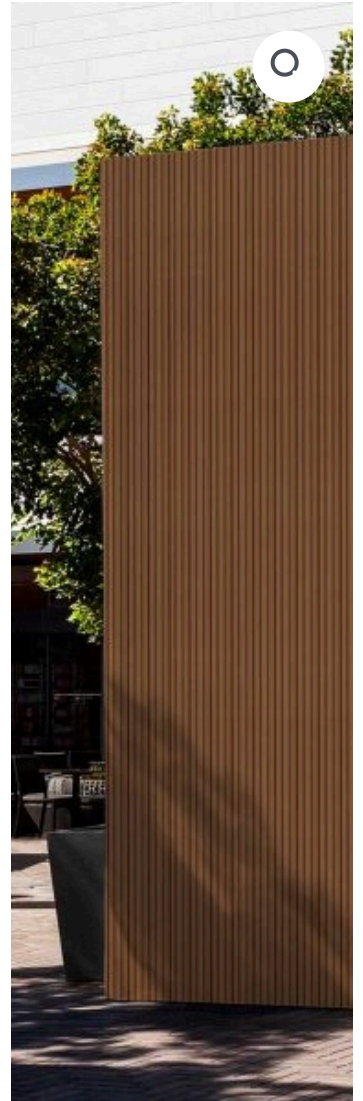

Wood Tech Siding Exterior Wall Panel – Maple Oak

CAD160.00 – CAD189.00

Size

7.87ft / 2 Pack

CLEAR

Out of stock

~~CAD228.00~~ **CAD160.00**

1



Add to Cart

Wood Tech Exterior Siding Wall Panel – Maple

Our Wood Tech Exterior Wall Panel products are perfect for outdoor space and it can uplift your property to make it natural timber beautiful look. It is a low maintenance product with no staining or painting required. WPC is made out of Eco-Friendly Materials. This WPC Cladding material is made out of lightweight composites that withstand heavy rains and high UV rays and it is 100% weather-proof and long-lasting wall panels.

Very in demand in luxury houses, hotels and high end commercial spaces around the world. You can now enjoy the same level of detail and quality in your own home, at a very affordable price.

Warranty	+
Specifications	+
Shipping	+
About Us	+
Reviews	+

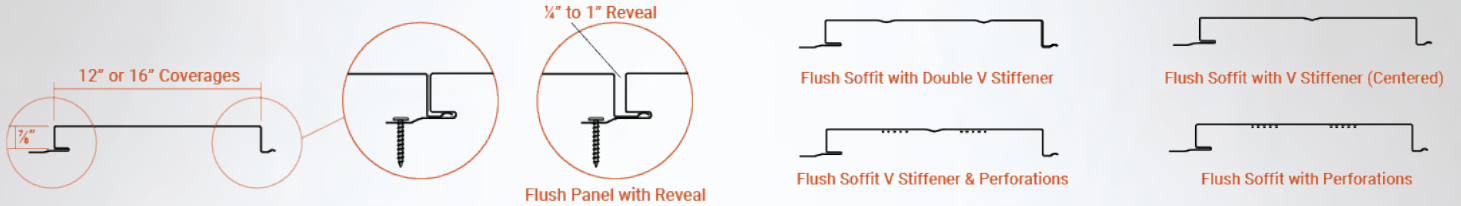
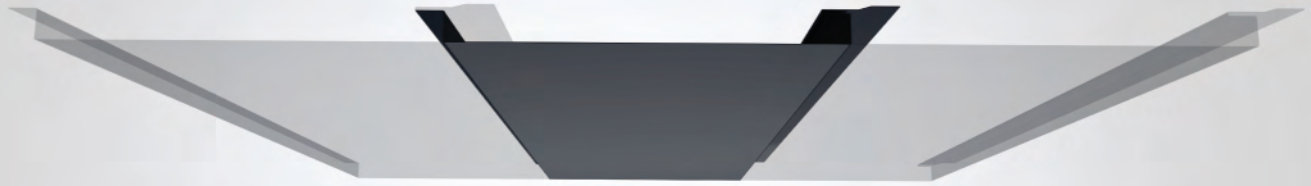

Panel Overlap Detail

- 1. Soffit Substrate:** Can be installed to wood framing, metal framing or plywood sheathing
- 2. Reveal Width:** No reveal shown, can be manufactured with up to 1" of reveal between panels in 1/4" increments.
- 3. Perforations:** Available in perforated version with air flow data available
- 4. Stiffeners:** Available in single v, double v, or no stiffener options

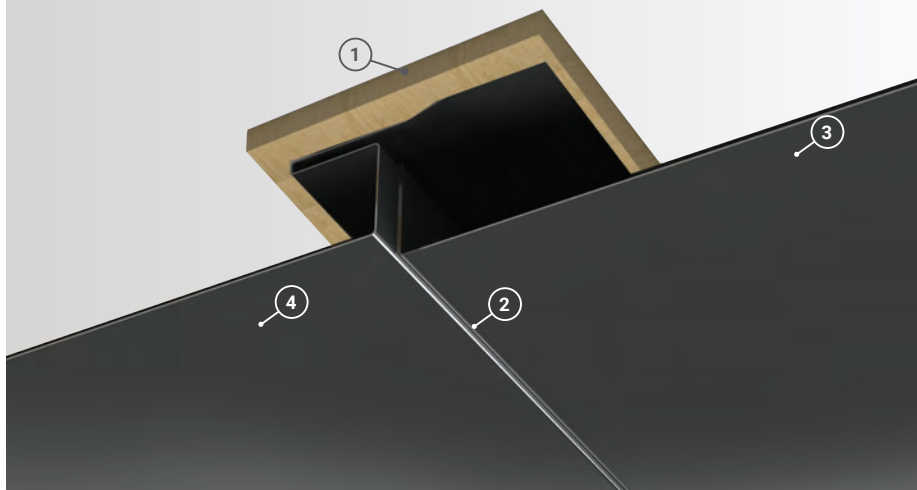

Soffit Coverage	12" or 16"
Reveal Widths	Flush to 1"
Panel Gauges	22, 24*
Fastener Options	Concealed Fastener
Panel Length	4' to 30'+
Relief Height	7/8"
Variegated Assembly	Available
Air Flow Data	Available Upon Request
Perforations	Available in 24 Gauge
Warranty	Based on Paint System
For more information	1.833.STEEL.US

* Grade 50

Version 5.2, 12/2021

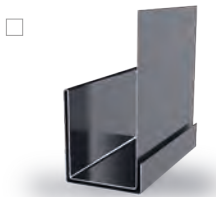

Double J Trim ***



Reverse J Trim *

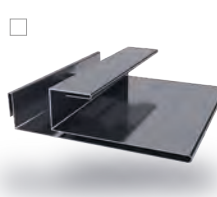

F & J Trim

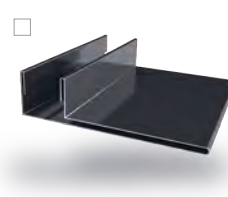

F Trim

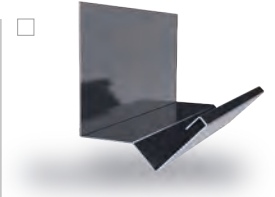

Head Trim

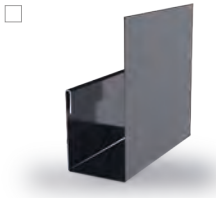

J Trim



Outside Corner



Outside Corner 2



Inside Corner

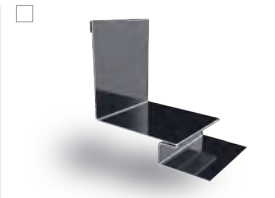

Inside Corner 2

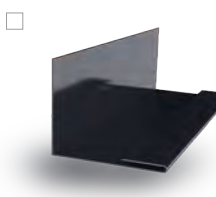

Inside Corner Closure



Fascia

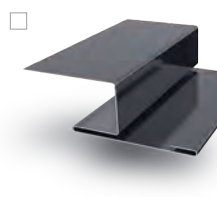

H Trim **

Additional Trim Profiles Available By Request

* Used with Outside & Inside Corner 2 and H Trim
** Used with Reverse J Trim
*** Color On Both Sides

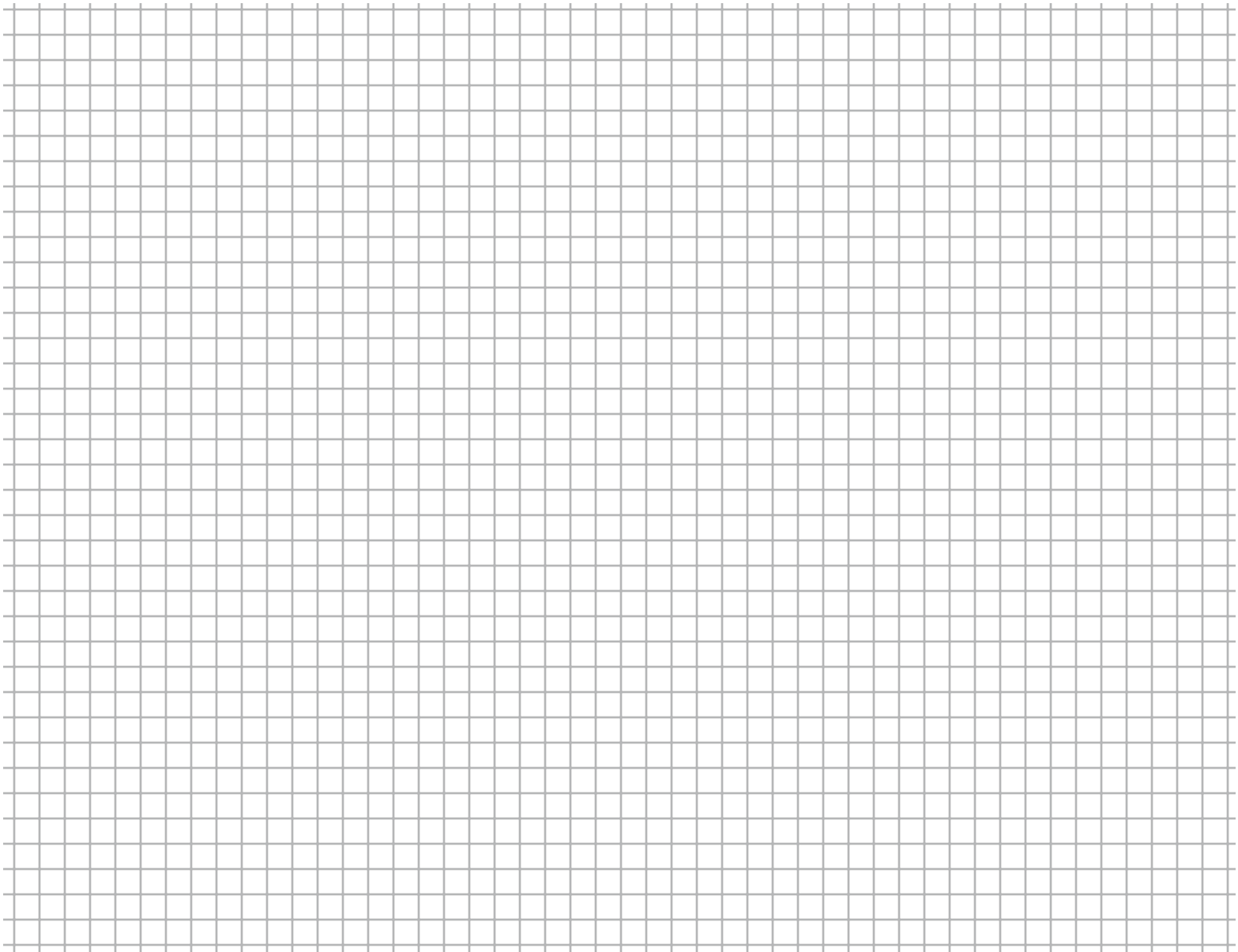

Pella® Lifestyle Series

Clad/Wood



6.

#1 performing wood window and patio door for the combination of energy, sound and value.¹

Triple-pane casement



Dual-pane casement



- **Performance redefined**

You don't have to compromise on any aspect of performance. Available performance solutions offer an unbeatable combination of energy efficiency, sound control and value.¹

- **ENERGY STAR® certified²**

Pella products offer energy-efficient options that will meet or exceed ENERGY STAR guidelines in all 50 states. Pella Lifestyle Series products with triple-pane glass have been awarded ENERGY STAR Most Efficient Mark in 2023.

- **Enhanced sound control**

Our patented, triple-pane design with Advanced Low-E glass allows for mixed glass thickness for enhanced sound dampening resulting in an average 52% noise reduction versus single-pane windows.³

- **Popular features and options**

Low-maintenance aluminum-clad exteriors. Factory prefinish with a choice of several paints and stains, or choose primed or unfinished. Several grille types and patterns and high-transparency screens are also available.

- **Intentional design for improved durability**

Intentional jamb/sill design helps seal the end grain of the wood and elevates it off the rough opening, reducing the potential for moisture.

- **Durable 3-way corner joint**

Three-way corner joints are made up of mortise-and-tenon, metal fasteners and commercial adhesive for added strength and durability.

- **Low-maintenance exteriors**

Aluminum-clad exteriors with EnduraClad® finish resists fading and chalking. It is applied in an overlapping fashion for exceptional protection.

- **Exclusive wood protection**

Pella's exclusive EnduraGuard® wood protection is applied after the pieces have been cut and milled, but prior to final assembly. It provides advanced protection against the effects of moisture, decay, stains from mold and mildew — as well as termite damage.

- **Best limited lifetime warranty⁴**

Pella Lifestyle Series products are covered by the best limited lifetime warranty in the industry for wood windows and patio doors.⁴

- **Testing beyond requirements**

At Pella, our products are tested beyond requirements to help ensure they have long-lasting performance and reduce call-backs for you.

Available in these window and patio door styles:⁵



Special shape windows also available.

^{1,2,3,4,5} See back cover for disclosures.

Product Specifications

Window & Patio Door Styles	Min. Width	Min. Height	Max. Width	Max. Height	Performance Class & Grade	Performance Values		
						U-Factor	SHGC	STC
Awning Dual-pane vent	21"	17"	59"	59"	LC30 - LC50	0.25 - 0.34	0.19 - 0.51	25-28
Awning Triple-pane vent	21"	17"	59"	59"	R20 - CW50	0.20 - 0.28	0.15 - 0.41	31-37
Casement Dual-pane vent	17"	17"	35"	73"	LC30-LC50	0.25 - 0.34	0.19 - 0.58	25-31
Casement Triple-pane vent	17"	17"	35"	73"	R20-CW50	0.20-0.25	0.17-0.46	31-37
Fixed Casement Dual-pane	17"	17"	73"	73"	LC30-LC50	0.23 - 0.35	0.20 - 0.57	29-32
Fixed Casement Triple-pane	17"	17"	73"	73"	R20-CW50	0.19 - 0.27	0.15 - 0.49	33-37
Double-Hung Dual-pane vent	21"	35"	48"	84"	LC30-LC50	0.25 - 0.34	0.20 - 0.48	27-31
Hinged Patio Door Dual-pane single door	30"	80"	38"	96"	LC50	0.26 - 0.32	0.18 - 0.48	31
Hinged Patio Door Triple-pane single door	30"	80"	38"	96"	LC55	0.23 - 0.28	0.12 - 0.34	34-36
Hinged Patio Door Dual-pane double door	60"	80"	75"	96"	LC50	0.25-0.29	0.18-0.48	30-32
Hinged Patio Door Triple-pane double door	50"	80"	75"	96"	LC55	0.22-0.26	0.14-0.38	34-36
Sliding Patio Door Dual-pane single-door fixed (O)	31"	80"	49"	96"	CW50	0.24-0.33	0.18-0.51	27
Sliding Patio Door Triple-pane single-door fixed (O)	31"	80"	49"	96"	CW60	0.21-0.27	0.17-0.45	33-36
Sliding Patio Door Dual-pane double-door vent (OX or XO)	60"	80"	96"	96"	R20-LC50	0.24 - 0.34	0.18-0.51	29-32
Sliding Patio Door Triple-pane double-door vent (OX or XO)	60"	80"	96"	96"	R25-LC60	0.22 - 0.29	0.16 - .44	33-36

Window sizes available in 1/4" increments

Special sizes available in triple-pane patio doors. For more information regarding performance, visit pella.com/performance. For more information regarding frame and installation types, visit installpella.com.

Window Hardware

Essential Collection

Select from popular designs and finishes to suit every style.



Fold-away Crank



Cam-Action Lock

Finishes:

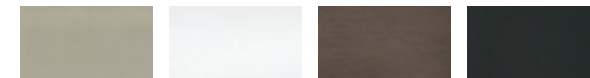

Champagne White Brown Matte Black



Satin Nickel Satin Brass

Patio Door Hardware

Essential Collection

Elevate your style and transform a home with elegant selections.



Hinged Patio Door Handle



Sliding Patio Door Handle

Finishes:



Champagne White Brown Matte Black



Satin Nickel Satin Brass

Colors

Prefinished Pine Interior Colors

We can prefinish pine in your choice of several paint and stain colors. Unfinished or primed and ready-to-paint are also available.



Aluminum-Clad Exterior Colors

Our low-maintenance EnduraClad® exterior finish resists fading and helps protect windows and patio doors for years. Seacoast EnduraClad protective finish for coastal projects with high salt exposure is also available.



Integrated Blinds⁶

Raise blinds up for an unobstructed view or tilt to let in just the right amount of light. Our best integrated and accessible blinds are available manual or motorized with Pella® Insynctive® technology.

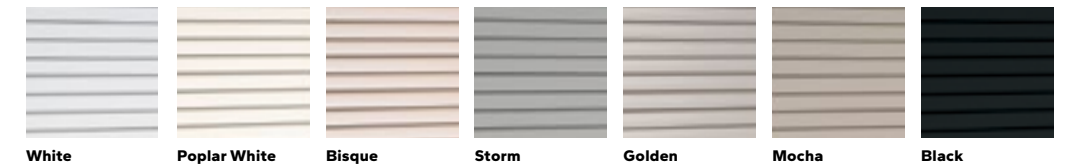

Integrated Shades⁶

Our best integrated fabric shades feature a white exterior fabric for a uniform look from the street. Integrated and accessible shades are available manual or motorized with Pella Insynctive technology.

Light-Filtering:

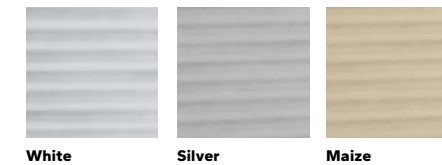

White Silver Maize

Room-Darkening:

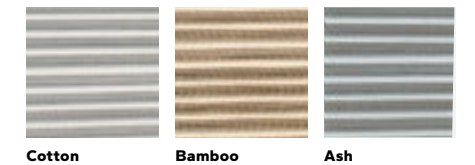

Cotton Bamboo Ash

Haven't landed on the final blind or shade color selection? No problem. With our patented triple-pane design, you and your customer can make those decisions later in the schedule. Our triple-pane products come with all of the hardware to add a blind or shade straight from the factory or at a later time in the building or remodeling process.

Added Peace of Mind

Integrated Security Sensors

Integrated wireless security sensors maintain aesthetics, streamline security installation and ensure no warranty loss is caused by post-installation drilling. Sensors can be monitored via the free Pella® Insynctive® App and are compatible with major security panel systems.⁷ For more information, go to connectpella.com.

^{6,7} See back cover for disclosures.

Performance Packages

To make things easier, we've created performance packages.

Performance solutions offer an unbeatable combination of energy efficiency, sound control and value.¹ Create room-by-room solutions with the upgraded triple-pane glass design.

All values below are averages compared with single-pane windows.

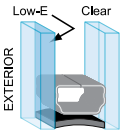
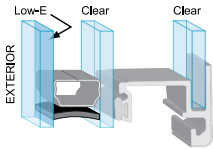
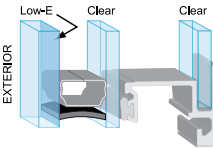
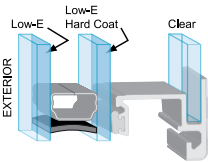
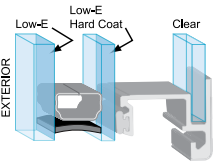

Pella® Lifestyle Series offers products awarded ENERGY STAR® Most Efficient for 2023.²

Base	Performance	Sound Control	Energy Efficiency	Ultimate Performance
	71% More Energy Efficient ⁸ + 34% Noise Reduction ³	52% Noise Reduction ³	83% More Energy Efficient ⁸	79% More Energy Efficient ⁸ + 52% Noise Reduction ³
 <p>Advanced Low-E</p> <p>Two panes of insulating, energy-efficient glass and our most popular features and options.</p>	 <p>Advanced Low-E SunDefense Low-E or NaturalSun Low-E</p> <p>A triple-pane glass design for a combination of both improved energy efficiency and sound performance.</p>	 <p>Advanced Low-E, SunDefense Low-E or NaturalSun Low-E Sound-reduction glazing</p> <p>Triple-pane glass design featuring mixed glass thicknesses for enhanced sound dampening.</p>	 <p>AdvancedComfort</p> <p>A triple-pane glass design with upgraded AdvancedComfort Low-E glass for enhanced energy efficiency.</p>	 <p>AdvancedComfort Sound-reduction glazing</p> <p>A triple-pane glass design featuring mixed glass thicknesses with upgraded AdvancedComfort Low-E glass for enhanced energy efficiency.</p>

Patented triple-pane glass design gives flexibility to add integrated blinds or shades without impacting performance.

Grilles

Choose the look of true divided light or make cleaning easier by selecting grilles-between-the-glass.

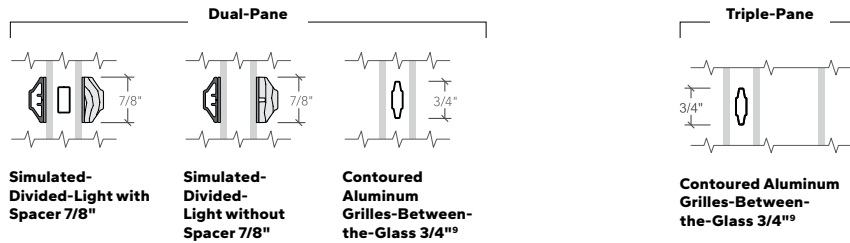

The Best Limited Lifetime Warranty in the Industry

We know your reputation matters and you stake your reputation on quality, dependable products. That's why we have the best limited lifetime warranty in the industry for wood windows and patio doors.⁴

¹ Performance solutions require upgrades to triple-pane, AdvancedComfort Low-E and mixed glass thickness. Based on comparing product quotes and published STC/OITC and U-Factor ratings of leading national wood window and patio door brands.

² Some Pella products may not meet ENERGY STAR certification in Canada. For more information, contact your local Pella sales representative or go to nrcan.gc.ca/energy/products/categories/fenestration/13739.

³ Reduction in sound based on OITC ratings of Pella Lifestyle Series windows with respective performance package compared to a single-pane wood or vinyl window with an OITC of 19. Calculated by using the sound transmission loss values in the 80 to 4000 Hz range as measured in accordance with ASTM E-90(09). Actual results may vary.

⁴ Based on comparing written limited warranties of leading national wood window and wood patio door brands. See written limited warranty for details, including exceptions and limitations, at pella.com/warranty.

⁵ Double-hung windows available in dual-pane only.

⁶ Available with triple-pane products only.

⁷ Requires the Insynctive App on a smart device, an Insynctive Bridge and a wireless home router with internet connection.

⁸ Window energy efficiency calculated in a computer simulation using RESFEN 6.0 default parameters for a 2000 sq. foot new construction single-story home when Pella Lifestyle Series windows with the respective performance package are compared to a single-pane wood or vinyl window. The energy efficiency and actual savings will vary by location. The average window energy efficiency is based on a national average of 94 modeled cities across the country and weighting based on population. For more details see pella.com/methodology.

⁹ Appearance of exterior grille color may vary depending on the Low-E insulating glass selection.

Extrudeck® series

The gold-standard of extruded aluminum canopies

7.

Extrudeck's® unique "J channel" water capture system makes this a functional yet attractive choice for any building. Its lightweight design provides protection from the elements and its easy hanger capability makes installation a snap. Extrudeck® is available pre-engineered in a wide variety of widths and lengths, a choice of finishing options will highlight your buildings facade.

Features and Benefits:

- Unique built-in drainage system
- Superior durability and lightweight design
- A variety of mounting options:
 - hanger rod, cantilever, post mount
- Pre-engineered
- Wide selection of fascia profiles, compliments any design
- Modular design and construction
- Weather protection
- Adjustable pitch
- Floating internal structure
- Surprisingly affordable

***MASA Architectural Canopies Ecoshade® and Extrudeck® systems can help you achieve LEED Credits.**

Innovative environmental control through creative design



Extrudeck® series

The gold-standard of extruded aluminum canopies

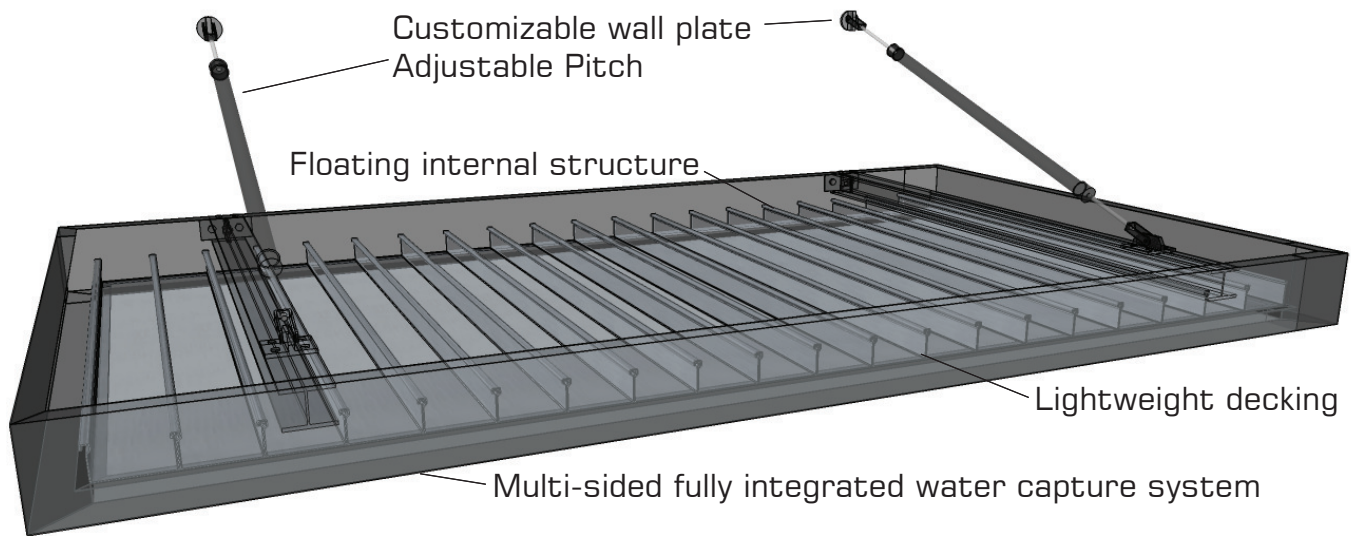

Applications: Doorways / Windows / Loading Docks / Walkways / Handicap ramps

Technical Data:

- All extrusions meet criteria for ASTM B221 and ASTM B429
- All products are engineered to meet standards of ASCE for design loads
- All channel framing is .125 6063-T5 high strength extruded aluminum

For PDF or AutoCAD Drawings go to: www.architecturalcanopies.com and click on downloads

Finishes:

- Standard finish super-durable Tiger Drylac Series 39 or 49 polyester resin based powder coating.

Other Finishes Available:

- Matthews/ppg Eurothane wet application
- Kynar Liquid Fluoropolymer

Full color palettes are also available for download at www.architecturalcanopies.com

All finishes are AAMA rated for excellent outdoor durability

Contact your Authorized Dealer



PARKING
ONLY
VAN
ACCESSIBLE





Standard Colors Chart



Bronze Matte Metallic
39/60020



Silver 1 Coat
(Clear Anodized Equivilant)
39/90000



White Matte
49/11350

Non-Standard Colors



Black Matte
39/80020

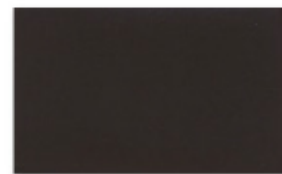

Roman Bronze Matte
39/60060



Federal Standard Haze Gray
49/70239



Bengal Silver 1Coat
49/99999

***Any Tiger Drylac Color Selection that is not on this chart is subject to change order**

Non-Standard

Will not add cost to project, but may add up to one week to production schedule. If a quote is produced with a Non-Standard color shown this cost will be included in the cost of goods. All colors are subject to availability and costs can change without notice.



Primary Entry Door (4 lites) and Secondary Entry Door (3 lites)

DOOR DESIGN

Customize this design by answering questions below, as desired. Click the "Quote This Door" button at any time to submit the quote request. Sun Mountain will confirm the request by e-mailing a PDF document illustrating the design and selected options. A sales representative will provide a free, no obligation price quote.

Whether a fully developed design or simply a rough idea with unanswered questions, click the "Quote This Door" button at any time to request a free, no obligation price quote.

1 DOOR

Is this an interior or exterior door?

Exterior Door ?

Is this a single or double door?

Single Door ?

Door width?

3' 0" ?

Door height?

8' 0" ?

Door thickness?

2-1/4" ?

Wood species, grade, and cut?

Oak (White), Select (\$\$\$) ?

Distressed wood?

No Distress ?

Glass style?

Pattern 62 (\$\$\$\$) ?

Sticking and panel profile, or applied moulding?

Not Sure ?

2 JAMB

What is the door's handing and swing?

Right Hand, Inswing ?

What is the jamb type?

Not Sure ?

Jamb width?

Not Sure ?

Hinge color?

Not Sure ?

Machining for hardware?

None (No Machining for Hardware) ?

3 FINISH

Wood finish?

Cinnamon Stain (\$) ?

4 CUSTOM FEATURES

Other custom features or notes?

?

DESIGN NUMBER: SQ-0003-D049-W



WOOD SPECIES AND FINISH: OAK (WHITE), SELECT, CINNAMON STAIN



GLASS: PATTERN 62



DISTRESS: NO DISTRESS

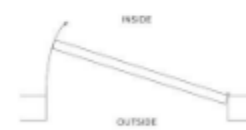

HANDING AND SWING: RIGHT HAND, INSWING



MACHINING: NONE (NO MACHINING FOR HARDWARE)



Get a Quote(/quote-request)



(<https://www.trudoor.com>)



Featuring Doors Made in the USA!

Commercial Hollow Metal Doors (<https://www.trudoor.com/commercial-hollow-metal-doors/>) > **2-Panel Metal Doors**



(<https://prod-trudoor-media.s3.us-west-2.amazonaws.com/wp-content/uploads/2019/05/21112129/2-panel-embossed-commercial-steel-door-e1593364961313.jpg>)

2-Panel Embossed Hollow Metal Door

Starting at **\$800**

Nationwide Delivery

The 2-panel design is perfect for applications that require a more traditional looking door without sacrificing the durability of a standard commercial metal security door. This heavy duty 2-panel steel door is an ideal solution for

condominium, apartment, hotel and motel entry doors and high-end residential buildings.

- Heavy Duty 18-Gauge A-40 Galvannealed Steel
- Insulated Polystyrene Core (Energy Efficient)
- Ideal for Exterior and Interior Applications

CONFIGURE & GET PRICE(/QUOTE-REQUEST/)

Product Overview

Heavy-duty 2-panel steel door for commercial and hospitality applications

2-Panel embossed doors are designed to meet the architectural requirements for embossed panel doors. This premium door construction combines the features and benefits of an insulated polystyrene core with laminated construction, for structural integrity, with the strength and dimensional stability of steel.

Features

- High definition embossed panels
- ADA compliant bottom rail
- Interlocking seam enhances structural rigidity and durability
- Factory-applied rust-inhibiting primer (no special color options)
- Fire-rated up to 3 hours with WHI / ITS mylar label applied (optional)



Specifications

Level	Heavy Duty, SDI Level 2 – 18-Gauge A-40 Galvannealed Steel Face Sheets
Core	Polystyrene Core
Thickness	1-3/4" Standard
Handing	Non-Handed or Handed (LH, RHR, RH, LHR)
Sizes	Width 3'0", Heights 6'8", 7'0", 8'0"

AVANTE[®]

garage doors

ALUMINUM AND GLASS CONSTRUCTION



America's Favorite Garage Doors[®]



Model AXU, Dark Bronze (Anodized) Frame with Obscure Insulated Glass

AVANTE®

Avante® garage doors are designed with architects, contractors and homeowners in mind. With a sleek aesthetic and section seal, these doors are the perfect choice to modernize any home. Not only can they transform garages, they can also be used as an indoor loft partition or as versatile solarium doors. Many glass options are available to control the degree of light transmission and privacy.



Model AXU

Model AX

STYLE AND CONSTRUCTION

- Aluminum frame provides a virtually maintenance-free, long-lasting door.
- Intellicore® polyurethane insulated rails and stiles. (Model AXU)
- R-value 3.8/U-factor 0.86. (Model AXU when glazed with clear insulated glass)
- Many glass and panel options available.
- Section joint seal helps keep out air and water.
- Integral reinforcing fin provides increased strength and longevity. (Available on double car models)
- Heavy-duty steel ball bearing rollers with nylon tires provide quiet operation.

**Doors wider than 14' include built-in reinforcing fin. Standard doors 12' and under do not use built-in reinforcing fin. Usage on widths 12'2" to 14' depend upon glass weight. WINDCODE® doors may vary. Contact your Clopay Dealer for details.*

Calculated door section R-value is in accordance with DASMA TDS-163.



FRAME/SOLID PANEL COLOR OPTIONS

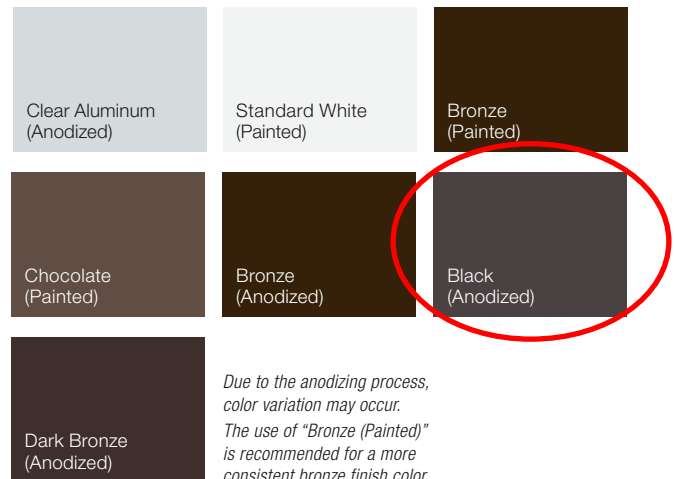

CUSTOM PAINT OPTIONS

Custom colors make Avante® garage doors personal. Choose a Color Blast® finish or RAL Powder Coating to create the perfect door. The only limit is your imagination! See your Clopay Dealer for details.



Model AXU not available with RAL Powder Coat finish.



Model AX, Bronze (Anodized) Frame with Frosted Tempered Glass

DOOR DESIGNS

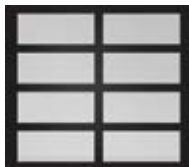

AX/AXU
Single car door



AX/AXU
Double car door

HARDWARE

Attractive color-matched aluminum grip handles.

Available in all standard color options.



WARRANTIES



GLASS/PANEL OPTIONS



Clear Glass*



Gray Tinted Glass*



Bronze Tinted Glass*



Mirrored Glass*



Obscure Glass*



Clear Laminated
Impact Rated Glass†

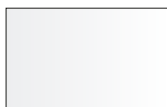

White
Laminated Glass



Black
Laminated Glass



Frosted Glass*
(Satin Etched)



Frosted Acrylic



Clear Acrylic



White Acrylic

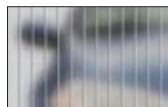

Clear Polygal™

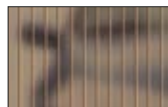

Bronze Polygal™



Clear Anodized
(Color-matched to frame)

- Glass available in single pane or insulated (laminated and mirrored glass not available insulated).
- Panels can be aluminum to match the aluminum frame. Glass/acrylic panels may be combined with aluminum panels. Custom glass and colors available.

WINDCODE®

Doors available to meet many regional wind load requirements.

WINDCODE® doors over 16' wide may have reinforcement hardware that shows through the glass panels of the door.

*Glass is tempered.

† 5/16" clear laminated impact rated glass is available only on AXW8/AXUW8.

Acrylic windows require special cleaning. Never use products that contain ammonia or petroleum products to clean acrylic. Please visit www.clopaydoor.com/acrylic for complete details.



See your Clopay Dealer for details. Or for more information scan this code.

PANEL CONFIGURATIONS (Examples of common sizes shown below)

6'6" TO 7'0" HIGH DOORS



2 Panel
Up to 9'2" Wide

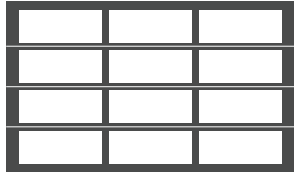

3 Panel
9'3" to 13'2" Wide

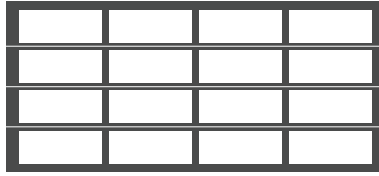

4 Panel
13'3" to 16'2" Wide

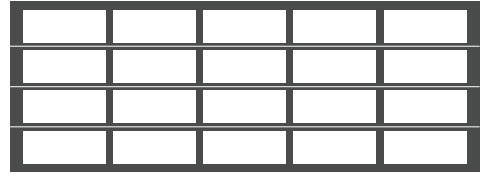

5 Panel
16'3" to 20'2" Wide

7'3" TO 8'0" HIGH DOORS

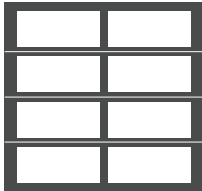

2 Panel
Up to 9'2" Wide



3 Panel
9'3" to 13'2" Wide



4 Panel
13'3" to 16'2" Wide

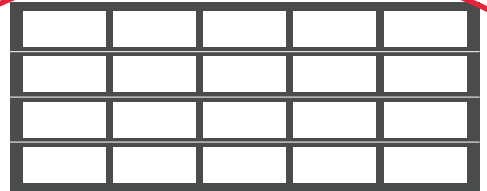

5 Panel
16'3" to 20'2" Wide



Model AXU, Black (Anodized) Frame with Frosted Insulated Glass



Visit clopaydoor.com or call 1-800-2CLOPAY (225-6729) for more information on Clopay, America's Favorite Garage Doors.

Follow us on



DESIGN YOUR DOOR
OPEN CAMERA
AND POINT!

©2023 Clopay Corporation. All rights reserved.

RSDR-AVANTEAXSS-19_REV1223

EXTERIOR WALL LIGHT



Bauhaus Inspired Wall Light in Black Bakelite and Opaline Glass

★★★★★

50% OFF Last 24 hour!

\$123 ~~\$246.00~~

Product Code: 54619131

Stock: In Stock

Attributes

Choose Size ▾

Size Guide

Qty:

[Add to cart](#)

Description



Bauhaus Inspired Wall Light in Black Bakelite and Opaline Glass



12.

Customers who viewed this item also viewed

12 Pack Recessed Lighting 4 Inch with Junction Box, 5CCT 4 Inch Black LED Recessed Lights Dimmable 2700K/3000K/4000K/5000K/6000K,

106

\$89⁹⁹ (\$7.50/Count)

zouzai 12 Pack 4 Inch Black 5CCT Reset Ultra-Thin LED Recessed Ceiling Light with Junction Box, 2700K/3000K/3500K/4000K/5000K

751

\$89⁹⁹ (\$7.50/Count)

Peteme LED Smart Recessed Lighting 4 Inch Recessed Light IC Rated ETL Certified, Canless Ceiling Light RGBCW Color Changing Outdoor

493

\$129⁹⁹ (\$21.67/Count)

Tools & Home Improvement › Electrical › Recessed Lighting › Housing & Trim Kits

CycevSun 12 Pack Black Recessed Lights, Canless 4 Inch Soffit Wafer Lighting with Junction Box, Dimmable & 3000K 4000K 5000K Selectable, 9W, 120Vac, Wet & IC Rated, ETL

Visit the CycevSun Store

4.7 198 ratings | 31 answered questions

-6% \$108⁹⁹ (\$9.08 / Count)

List Price: ~~\$115.99~~

FREE Returns

Coupon: Apply \$10 coupon Terms

Returnable until Jan 31, 2024 | Product support included

Color: **Black**



Size: **4 Inch 12-Pack**

4 Inch 12-Pack	4 Inch 6-Pack	6 Inch 2-Pack	6 Inch 6-Pack	6 Inch 12-Pack
\$108.99 (\$9.08 / Count)	\$69.99	\$25.89 (\$12.95 / Count)	\$79.99	\$119.99 (\$10.00 / count)
4 Inch 16-Pack	4 Inch 24-Pack	6 Inch 16-Pack		
See available options	See available options	See available options		

Brand CycevSun
Color Black
Material Aluminium, Acrylic
Style Modern
Light fixture form Recessed

About this item

- 💡 **[5 Color Temperature Selectable]** - The black recessed lights has a simple switch on the back to preset your preferred light color temperature: warm white 3000K, neutral white 4000K, or daylight 5000K.
- 💡 **[Smooth Dimmable]** - The black recessed lights use American advanced dimming chips, which ensure smooth dimmable 100%-5% without flicker and buzz.
- 💡 **[Trustworthiness]** This black led recessed lighting is IC rated, ETL and wire terminal is UL-certified. It is permitted to be in contact with insulations in ceilings, meaning the junction box is thermally protected.
- 💡 **[High Brightness & Energy Saving]** - Using high-brightness LED and PMMA light guide plate to emit uniform light with no dim and yellow over time.



Enjoy fast, free delivery, exclusive deals, and award-winning movies & TV shows with Prime
 Try Prime and start saving today with fast, free delivery

Delivery

Pickup

\$108⁹⁹ (\$9.08 / Count)

FREE Returns

FREE delivery **Wednesday, December 20**

Or fastest delivery **Thursday, December 14.** Order within 6 hrs 28 mins

Arrives before Christmas

Delivering to Columbus 43215 - Update location

In Stock

Qty: 1

Add to Cart

Buy Now

Ships from Amazon
 Sold by CycevSun Lighting
 Returns Returnable until Jan 31, 2024
 Support Product support included

See more

Add a Protection Plan:

- 3-Year Protection for \$21.99
- 4-Year Protection for \$29.99

Add a gift receipt for easy returns

Add to List

New & Used (3) from \$100⁵⁰ & FREE Shipping.



Roll over image to zoom in



- 💡 **【Easy Installation】** - This 4 inch led recessed lights is only 0.98 inch, fits various ceilings, and joists. Comes with snap-in bushings for knockout, and wire nuts.

[See more product details](#)

Make it a bundle

We found 1 bundle with this item:



CycevSun 12 Pack 4 Inch Black Recessed Light & 16 Pack 4 Inc...

\$246⁰³ ~~\$295.98~~

This bundle contains 2 items

CycevSun 12 Pack Black Recessed Lights, Canless 4 Inch Soffit Wafer Lighting with Junction Box, Dim...

Frequently bought together



+



+



Total price: **\$343.96**

Add all 3 to Cart

These items are shipped from and sold by different sellers.
[Show details](#)

This item: CycevSun 12 Pack Black Recessed Lights, Canless 4 Inch Soffit Wafer Lighting with...

\$108⁹⁹ (\$9.08/Count)

Amico 24 Pack 6 Inch 5CCT Ultra-Thin LED Recessed Ceiling Light with Junction Box,...

\$139⁹⁸ (\$5.83/Count)

Amico 12 Pack 4 Inch 5CCT Ultra-Thin LED Recessed Dimmable Can/Ceiling Light with Junction...

\$94⁹⁹ (\$7.92/Count)

Customers frequently viewed

Page 1 of 30

Sponsored | Popular products in the last 7 days



Amico 24 Pack 4 Inch 5CCT Ultra-Thin LED Recessed Ceiling Light with Junction Box, ...

686

Limited time deal
\$129.99 (\$5.42/Count)

Save \$10.00 with coupon
List: ~~\$169.99~~ (24% off)



12 Pack Recessed Lighting 4 Inch with Junction Box, 5CCT 4 Inch Black LED...

106

\$89.99 (\$7.50/Count)

Save 5% with coupon



12 Pack 6 Inch LED Recessed Lights with Junction Box, 5CCT Black Recessed Lighting ...

24

\$62.99 (\$5.25/Count)



CycevSun 12 Pack Black Recessed Lights 6 Inch with Night Light - Canless Ultra Thin...

164

\$139.99 (\$11.67/Count)

Save \$8.00 with coupon



FREELICHT 24 Pack 4 Inch 5CCT Ultra-Thin LED Recessed Ceiling Light with Junction B...

121

\$119.99 (\$5.00/Count)

Save \$20.00 with coupon



POWERASIA 12 Pack 4 Inch Ultra-Thin LED Recessed Ceiling Light with Junction Box...

805

Limited time deal
\$62.38 (\$5.20/Count)

List: ~~\$77.99~~ (20% off)

Deals on related products

Page 1 of 3



Sponsored ⓘ

Amico 24 Pack 4 Inch 5CCT Ultra-Thin LED Recessed Ceiling Light with Junction Box, ...
686

Limited time deal

\$129.99 (\$5.42/Count)
List: ~~\$169.99~~ (24% off)



Sponsored ⓘ

12 Pack 4 Inch LED Recessed Lights with Junction Box, 5CCT Black Recessed Lighting ...
24

Limited time deal

\$62.39 (\$5.20/Count)
List: ~~\$71.99~~ (13% off)



Sponsored ⓘ

POWERASIA 12 Pack 4 Inch Ultra-Thin LED Recessed Ceiling Light with Junction Box, 5...
805

Limited time deal

\$62.38 (\$5.20/Count)
List: ~~\$77.99~~ (20% off)



Sponsored ⓘ

Sunco 24 Pack 4 Inch LED Can Lights Retrofit Recessed Lighting, Selectable 2700K/30...
340

Limited time deal

\$76.49 (\$3.19/Count)
List: ~~\$167.99~~ (54% off)



Sponsored ⓘ

Meconard 12 Pack 4 Inch LED Recessed Ceiling Light with Junction Box, 2700K/3000K/3...
243

Limited time deal

\$48.99 (\$4.08/Count)
List: ~~\$69.99~~ (30% off)

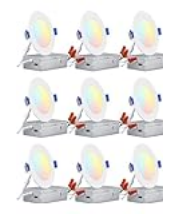

Sponsored ⓘ

TORCHSTAR 12-F 5CCT 4 Inch Ultra LED Recessed Ligh with Junction Box
5,36

Limited time deal

\$69.98 (\$5.83/c)
List: ~~\$119.99~~ (42% c

Product information

Technical Details

Brand	CycevSun
Color	Black
Material	Aluminium, Acrylic
Style	Modern
Light fixture form	Recessed
Room Type	Soffit, Kitchen, Bedroom, Bathroom, Living Room, Hallway, Porch
Product Dimensions	4.72"L x 4.72"W x 0.98"H
Specific Uses For Product	Indoor use only
Indoor/Outdoor Usage	Outdoor, Indoor
Power Source	AC
Installation Type	Recessed
Special Feature	Energy Efficient, Dimmable, Easy to install without a can, 3000K-4000K-5000K 3 Color Temperature Selectable, IC Rated & Wet Rated
Control Method	Touch
Light Source Type	LED
Finish Type	Powder Coated
Shade Material	Acrylic
Number of Light Sources	120
Voltage	120 Volts
Theme	Black
Light Color	Warm white 3000K, neutral white 4000K, or daylight 5000K options
Shape	Round
Included Components	Wire Nuts, Junction Box
Embellishment	Bright
Warranty Type	Limited
Lighting Method	Downlight
Specification Met	FCC, ETL
Item Weight	1 Pounds
Number of Items	12
Wattage	9 watts

Additional Information

ASIN	B0916YT37J
Customer Reviews	4.7 4.7 out of 5 stars 198 ratings
Best Sellers Rank	#71,789 in Tools & Home Improvement (See Top 100 in Tools & Home Improvement) #255 in Recessed Lighting Housing & Trim Kits
Date First Available	March 29, 2021

Warranty & Support

Amazon.com Return Policy: **Amazon.com Voluntary 30-Day Return Guarantee:** You can return many items you have purchased within 30 days following delivery of the item to you. Our Voluntary 30-Day Return Guarantee does not affect your legal right of withdrawal in any way. You can find out more about the exceptions and conditions [here](#).

Product Warranty: For warranty information about this product, please [click here](#)

Feedback

Would you like to [tell us about a lower price?](#)

Controller Type	Push Button
Switch Type	Push Button
Unit Count	12 Count
Water Resistance Level	Not Water Resistant
Brightness	750 Lumen
Mounting Type	Recessed
Shade Color	White
Fixture Type	Non Removable
Assembly Required	No
Manufacturer	CycevSun
Part Number	Black Recessed Lights
Item Weight	1 pounds
Country of Origin	China
Item model number	DO-RSD-04-9W-CCT
Is Discontinued By Manufacturer	No
Finish types	Powder Coated
Maximum Compatible Wattage	9 Watts
Special Features	Energy Efficient, Dimmable, Easy to install without a can, 3000K-4000K-5000K 3 Color Temperature Selectable, IC Rated & Wet Rated
Plug Format	A- US style
Batteries Included?	No
Batteries Required?	No
Bulb Features	Dimmable
Color Temperature	30004000500 Kelvin
Color Rendering Index (CRI)	80.00
Average Life	30000 Hours
Bulb Diameter	4.7 Inches
Bulb Length	4.7 Inches

Product details

Is Discontinued By Manufacturer : No

Product Dimensions : 4.72 x 4.72 x 1 inches; 1 Pounds

Item model number : DO-RSD-04-9W-CCT

Date First Available : March 29, 2021

Manufacturer : CycevSun

ASIN : B0916YT37J

Country of Origin : China

Customer Reviews:

4.7

[198 ratings](#)

Inspiration from this brand



CycevSun

[Visit the Store on Amazon](#)

+ Follow



What can we help you find today?



Daly City 10PM

94015

Home / Lumber & Composites / Fencing / Outdoor Privacy Screens

Internet # 326842999 Model # yuyuanx011yw Store SKU # 1010211076

6 ft. x 6 ft. Black Wood Plastic Composite Fence WPC Outdoor Garden Fence without Column (9-Piece Set)

A.

★★★★☆ (2) Questions & Answers (4)

Live Chat
Feedback



Hover Image to Zoom

Share Print

Shop All

Services

DIY

Me

\$278.60 /carton



Save up to **\$100** on your qualifying purchase ⓘ

[Apply for a Home Depot Consumer Card](#)

Color/Finish: **black**



Pickup at [Daly City](#)

Delivering to [94015](#)

Ship to Store

Dec 19 - Dec 22

94 available

FREE

Delivery

Thursday, Dec 21

94 available

FREE

Live Chat

Feedback



Add to Cart



Free & Easy Returns In Store or Online

Return this item within **90 days** of purchase. [Read Return Policy](#)

Product Details

Our fence panel set can be used as garden barrier or residential fence for privacy and security. The garden fence is a wood-plastic board, using co-extrusion technology, with a protective film on the surface, which can prevent scratches and fix colors. This fence set is easy to assemble. After assembly, the size is 70.9 in. (H) x 70.9 in. (W) x 0.8 in. (T), a single fence panel size is 70.9 in. (L) x 7.7 in. (W) x 0.8 in. (T).

Additional Resources

From the Manufacturer



Aoibox

16 in. White Digital Wall Mount Fan with...

★★★★★ (2)

\$162⁷⁴ /package

Specifications



Dimensions

Product Depth (in.)	0.8 in
Product Height (ft.)	6 ft
Product Width (ft.)	6 ft



Details

Color Family	Black
Color/Finish	black
Fence Application	Garden, Privacy
Garden Fencing Type	Border Fence
Landscape Supply Type	Garden Fencing
Material	Plastic
Package Quantity	1
Returnable	90-Day

How can we improve our product information? [Provide feedback.](#)

Questions & Answers



4 Questions

Customer Reviews



3 out of 5 (2)

Wrought Iron Gate and Fence Profile



C.

Trex Transcend® Lineage™ Composite Decking

Transcend Lineage decking with heat-mitigating technology that makes it our coolest decking yet.*
Literally.



Trex Transcend® Lineage™ Composite Decking

FEATURES

Stunning Color Options

Transcend Lineage comes in five luxurious, on-trend colors: Island Mist, Rainier, Carmel, Biscayne, Jasper. These tranquil tones create a clean canvas for your outdoor space. Find the perfect fit for your deck with our [Trex Color Selector](#).

Cooler Under the Sun*

composite decking products of a similar color, on a hot sunny day, it will get hot. On hot days, care should be taken to avoid extended contact between exposed skin and the deck surface, especially with young children and those with special needs.

Durable & Long-lasting

Transcend Lineage decking maintains its vibrant color and luxurious finish—come scorching sun or red-wine spill—thanks to its unyielding shell protection. (Not to mention simple [soap-and-water cleanup](#).) Backed by a 50-year Limited Residential Warranty.

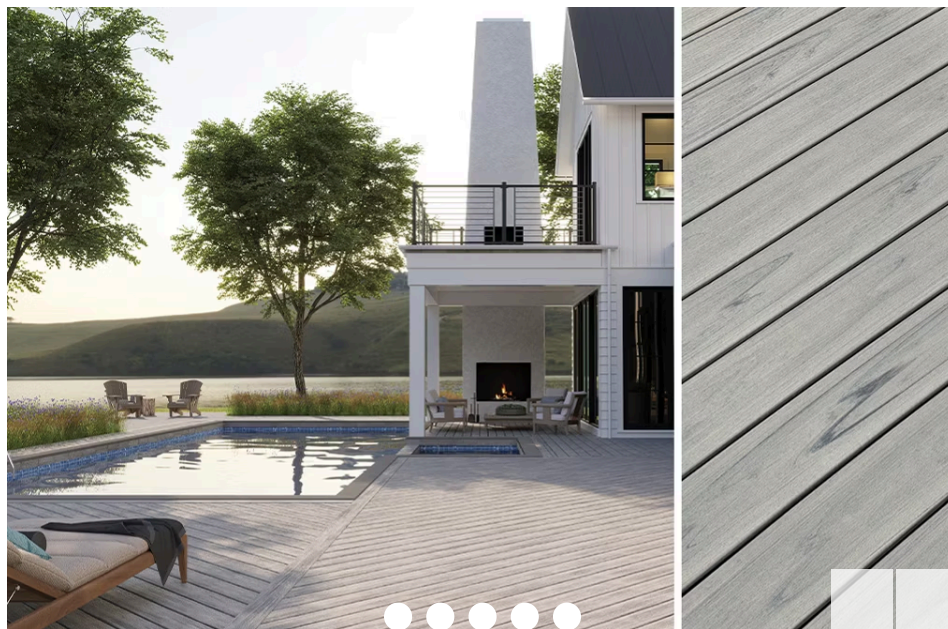

Transcend® Lineage™



Color: Rainier

An airy, mountain grey, Rainier mirrors white-capped mountains and wooded sounds, with its subtle silver tones and delicate grain pattern.

Exterior Balcony Perimeter Metal Frame and Horizontal Cable Guard



Turn corners with one post

Most companies force you to use two posts to turn a corner on your railing system. Our pre-fabricated posts and proprietary hardware empower you to turn corners with a single post, cutting down on material costs and opening up your view even more.

The difference is in the details

1-on-1 support

—

Every customer is paired with a dedicated rep and one of our expert engineers who will see your project through from start to finish.

Custom engineering

—

Your railing system is engineered for your space, with the precise amount of posts, infill, and handrail you need, and unique components like corner posts designed to make your railing feel custom.

Premium materials

—

Other companies use cheaper materials like Zinc for their posts and components. Our railings are made with high-grade aluminum or stainless steel with the best powder coat on the market, engineered to last a lifetime.

Post spacing

—

Other companies space their posts out as far as code will allow, but our systems are engineered with posts spaced 4 feet apart (center to center) to enhance the strength of the system and exceed code requirements. (Read more about [code requirements](#).)

