

April 9, 2024

1485 Longfellow St.,
Detroit, MI 48206

RE: 1485 Longfellow Exterior Renovations, District Historic Commission Submission

Window, Door, and Railing Cut Sheets

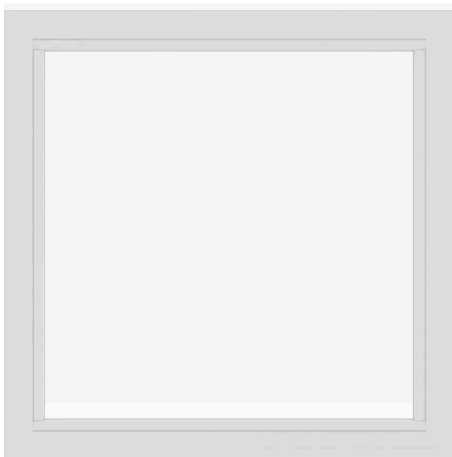
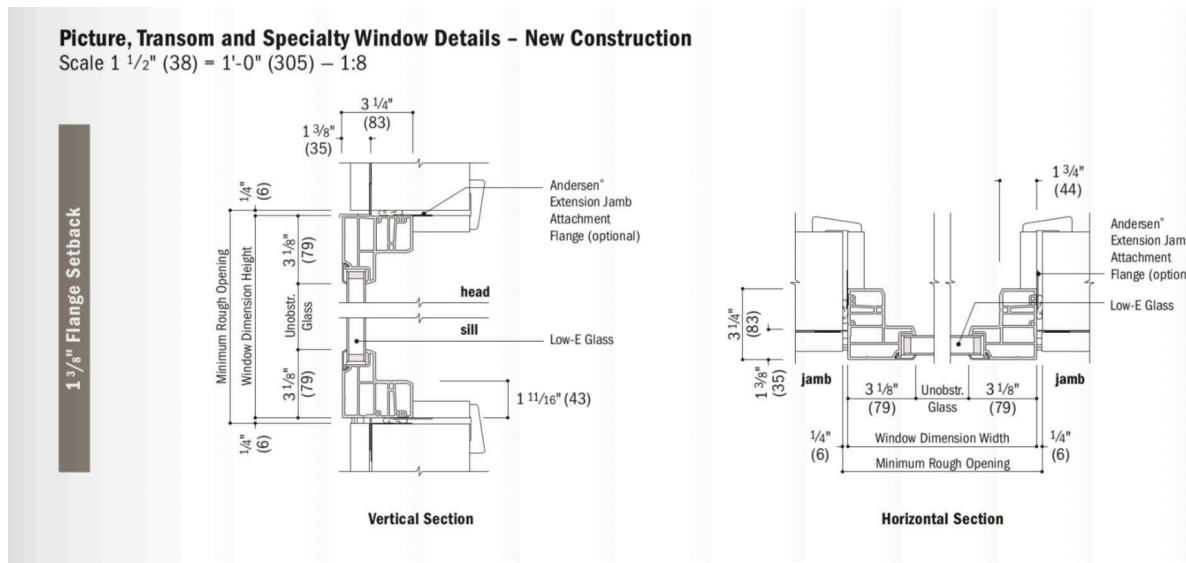

Single-Hung Window Details - New Construction

Scale 1 1/2" (38) = 1'-0" (305) - 1:8

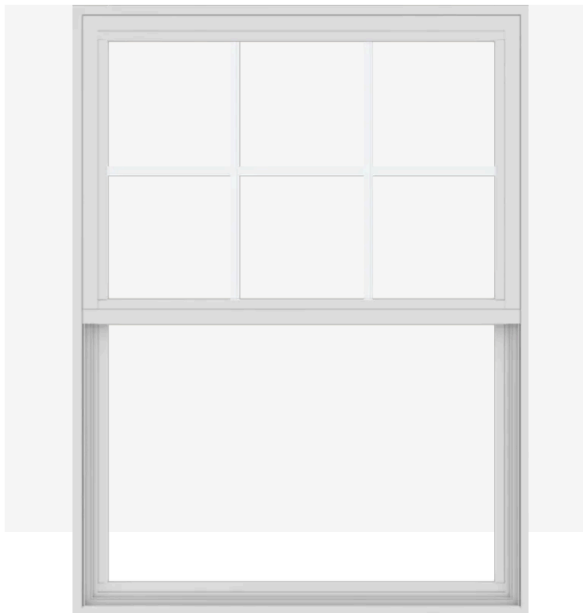
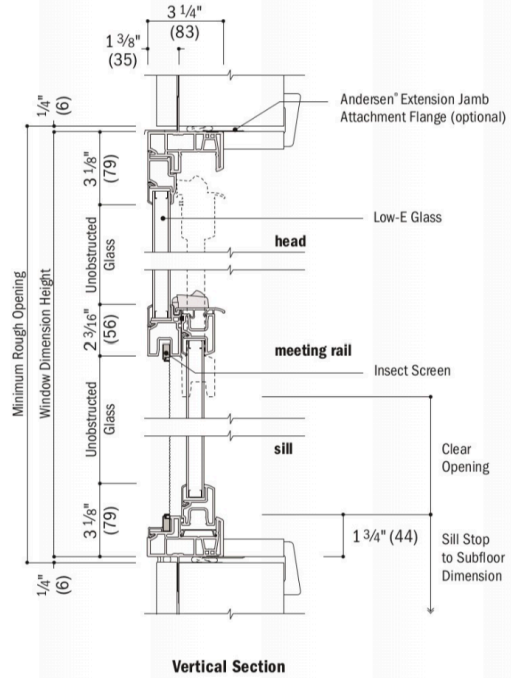
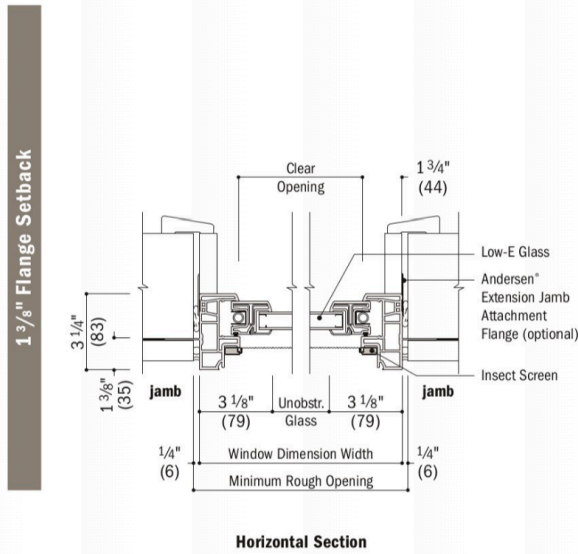

Springline™ Outswing Entry Door Details – 4 9/16" (116) Jamb Depth

Scale 1 1/2" (38) = 1'-0" (305) – 1:8

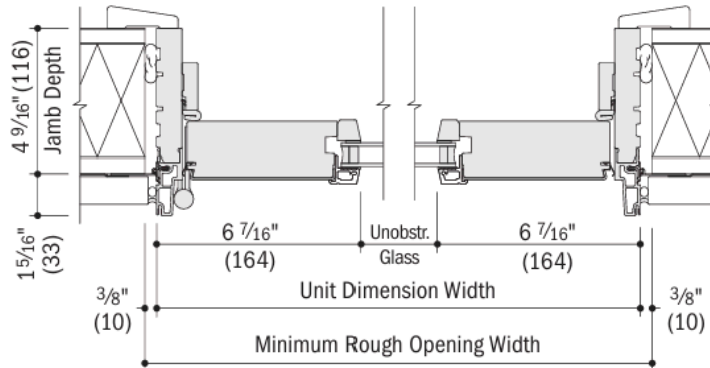

Horizontal Section

Panel Style 194 Straightline Glass Panel



RAIL KITS



COMPONENT	RAIL & SQUARE COMPOSITE BALUSTER KIT	RAIL & ROUND ALUMINUM BALUSTER KIT	COCKTAIL RAIL & ROUND ALUMINUM BALUSTER KIT*
Top Rail	Crown	Crown	Universal
Bottom Rail	Universal	Universal	Universal
Heights	36" (914 mm) 42" (106 cm)	36" (914 mm) 42" (106 cm)	36" (914 mm)
Lengths	67.5" (171 cm) 91.5" (232 cm)	67.5" (171 cm) 91.5" (232 cm)	67.5" (171 cm) 91.5" (232 cm)
Applications	Horizontal, Stair	Horizontal, Stair	Horizontal, Stair
Colors	WT, BK, VL	WT, BK, VL (round aluminum balusters come in BK)	WT (round aluminum balusters come in BK)

*A cocktail rail allows for a Trex Transcend® or Trex Select® deck board to be installed on top of a Universal top/bottom rail. All deck boards sold separately.

COLORS

Composite



Aluminum

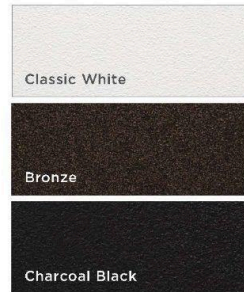

CODE REQUIREMENTS

Trex Transcend Railing meets both IRC and IBC designated requirements in accordance with ICC-ES AC174 and ASTM D7032. Refer to Code Compliance Report CCRR-0132 for specific details.

HARDWARE

Mounting Hardware for Cut Rails

The perfect solution for any installation that requires making two railing sections from one kit.

Includes 2 Crown top rail gaskets, 4 Universal top/bottom rail gaskets, 4 RSB rail brackets, 8 rail-to-bracket fasteners and 8 rail-to-post fasteners.



QUESTIONS?

Connect with our pro services team at
1-800-BUY-TREX or customer-care@trex.com